

Thursday 2nd April

Writing

Letter Formation

Choose some words from your story and practise your handwriting using the letter formation sheet from last week. You can print the sheet or use your own paper.

e.g.

frog \_\_\_\_\_

tower \_\_\_\_\_

apple \_\_\_\_\_

\_\_\_\_\_

\_\_\_\_\_

\_\_\_\_\_

\_\_\_\_\_

\_\_\_\_\_

\_\_\_\_\_

Thursday 2nd April

Maths

# Ladybird Doubles

Write the number sentence for each ladybird double.

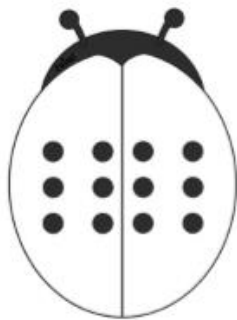

$6+6= \underline{\quad}$



$2+2= \underline{\quad}$

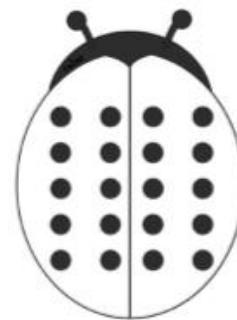

$10+10= \underline{\quad}$

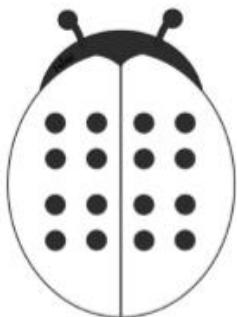

$8+8= \underline{\quad}$

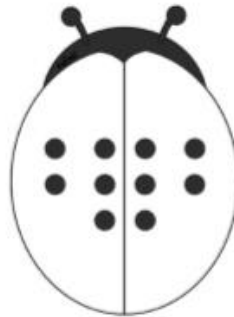

$5+5= \underline{\quad}$

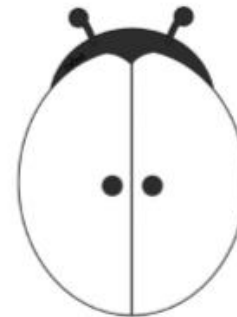

$1+1= \underline{\quad}$

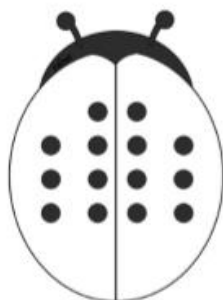

$7+7= \underline{\quad}$

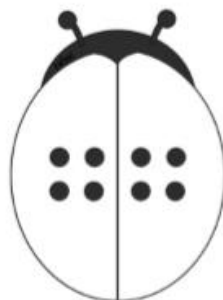

$4+4= \underline{\quad}$

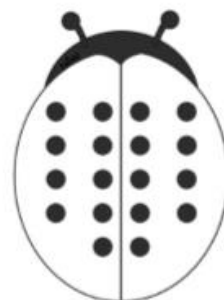

$9+9= \underline{\quad}$



$3+3= \underline{\quad}$

Thursday 2nd April

## Letters and Sounds

Read the story and get your child to underline or copy out the words that contain the 'igh' trigraph.

Can they think of any more?

Can they write their own sentence with the words in?

# The Light in the Night

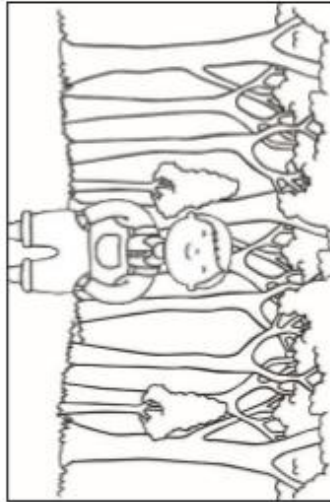

Dwight was in the woods. He often went to the woods with his mum and dad.



They had a hut that had beds in it. In the summer, they slept in the hut.

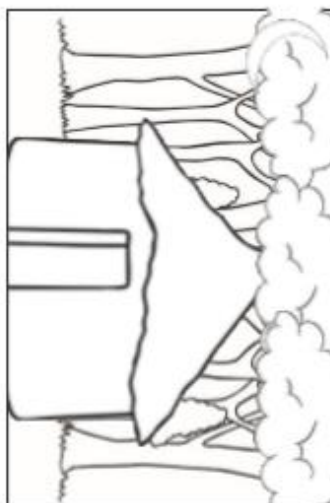

The wood was dark at night. The hut was dark too. It did not contain a light.

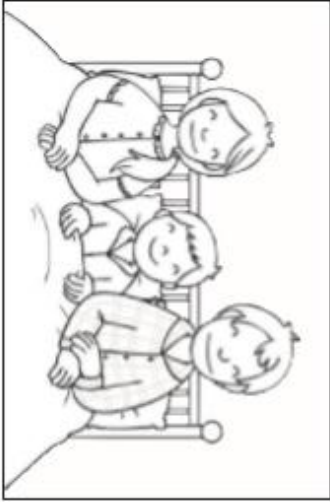

Dwight slept next to his mum and dad, as he often got a fright.

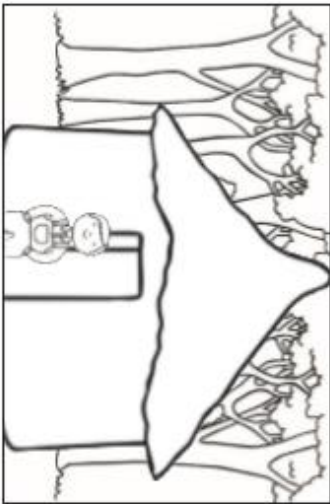

One night in winter, Dwight had to sleep in the hut, as his mum and dad went to hunt for food.

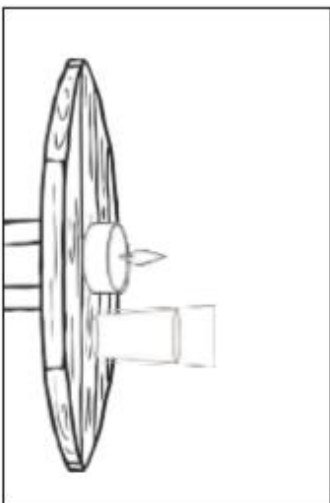

Then, he did see a bright light. His mum and dad had put it next to his bed. He did not need to feel afraid.

Thursday 2<sup>nd</sup> April

Topic

Make a musical instrument out of junk. Here are some ideas to help you.

